

MAXIM

MAX1715 Evaluation Kit

Evaluates: MAX1715

General Description

The MAX1715 evaluation kit (EV kit) demonstrates the MAX1715's standard 4A application circuit. This DC-DC converter steps down high-voltage batteries and/or AC adapters, generating precision, low-voltage rails for use as chipset, DRAM supplies, and low-voltage supplies.

The MAX1715 EV kit provides dual 1.8V and 2.5V output voltages from a 5V to 24V battery input range. It delivers up to 4A output current for each output with greater than 90% efficiency, operating at 255/345kHz switching frequency, and has superior line- and load-transient response.

This EV kit is a fully assembled and tested circuit board. It also allows the evaluation of other output voltages in the 1.0V to 5.5V range by changing feedback resistors R1–R4.

Features

- ◆ +5V to +24V Input Voltage Range
- ◆ Preset 1.8V and 2.5V Output Voltages
- ◆ 1.0V to 5.5V Adjustable Outputs
- ◆ 4A Output Current
- ◆ 255/345kHz Switching Frequency
- ◆ No Current-Sense Resistor
- ◆ Power-Good Output
- ◆ 28-Pin QSOP Package
- ◆ Low-Profile Components
- ◆ Fully Assembled and Tested

Ordering Information

PART	TEMP. RANGE	IC PACKAGE
MAX1715EVKIT	0°C to +70°C	28 QSOP

Component List

DESIGNATION	QTY	DESCRIPTION
C1, C2	2	10 μ F, 25V ceramic capacitors (1812) Taiyo Yuden TMK432BJ106KM or Tokin C34Y5U1E106Z
C3, C4	2	330 μ F, 6.3V low-ESR capacitors Kemet T510X337M010AS or Sanyo 6TPB330M
C5, C6	2	0.1 μ F ceramic capacitors (0805)
C7	1	0.22 μ F ceramic capacitor (1206)
C8	1	1 μ F, 10V X5R ceramic capacitor (0805) Taiyo Yuden LMK212BJ105MG
C9	1	4.7 μ F, 16V tantalum capacitor Sprague 595D475X0016A2B
C10, C11	0	Not installed
C12, C13	2	1000pF ceramic capacitors (1206)
C14	1	3.3 μ F, 10V X5R ceramic capacitor (1206) Taiyo Yuden LMK316BJ335ML
D1, D2	2	1A, 30V Schottky diodes Nihon EP10QY03
D3	1	100mA, 30V dual Schottky diode Central Semiconductor CMPSH-3A

DESIGNATION	QTY	DESCRIPTION
L1	1	3.9 μ H power inductor Sumida CDRH124-3R9MC
L2	1	4.7 μ H power inductor Sumida CDRH124-4R7MC
N1A, N1B, N2A, N2B	2	Dual N-channel MOSFETs Fairchild FDS6982
R1, R3, R9, R10	0	Not installed
R2, R4	2	10k Ω \pm 1% resistors (1206)
R5	1	100k Ω \pm 5% resistor (1206)
R6, R7, R8	3	1M Ω \pm 5% resistors (1206)
R11, R12	2	100 Ω \pm 5% resistors (0805)
R13	1	20 Ω \pm 5% resistor (1206)
U1	1	MAX1715EEI (28-pin QSOP)
SW1	1	DIP-6 dip switch
None	4	Rubber feet
None	1	MAX1715 PC board
None	1	MAX1715 data sheet
None	1	MAX1715 EV kit data sheet

MAX1715 Evaluation Kit

Component Suppliers

SUPPLIER	PHONE	FAX
AVX	803-946-0690	803-626-3123
Central Semiconductor	516-435-1110	516-435-1824
Coilcraft	708-639-6400	708-639-1469
Coiltronics	561-241-7876	561-241-9339
Fairchild	408-721-2181	408-721-1635
Kemet	408-986-0424	408-986-1442
Motorola	602-303-5454	602-994-6430
Nihon	847-843-7500	847-843-2798
Sanyo	619-661-6835	619-661-1055
Sumida	708-956-0666	708-956-0702
Taiyo Yuden	408-573-4150	408-573-4159
Tokin	408-432-8020	408-434-0375

Note: Please indicate that you are using the MAX1715 when contacting these component suppliers.

Quick Start

The MAX1715 EV kit is fully assembled and tested. Follow these steps to evaluate the MAX1715 standard 4A application circuit:

- 1) Ensure that the circuit is connected correctly to the supplies and dummy load. **Do not turn on power until all connections are made.**
- 2) Verify that switches ON1 and ON2 (SW1) are in the on position.

Table 2. Switch SW1 Functions

SW1 LOCATION	ON1 PIN	ON2 PIN	SKIP PIN
ON1 = on	Connected to V _{CC} , V _{OUT1} = 1.8V	—	—
ON1 = off	Connected to GND, V _{OUT1} = 0	—	—
ON2 = on	—	Connected to V _{CC} , V _{OUT2} = 2.5V	—
ON2 = off	—	Connected to GND, V _{OUT2} = 0	—
SKIP = on	—	—	Connected to V _{CC} , low-noise mode, forced fixed-frequency PWM operation.
SKIP = off	—	—	Connected to GND, normal operation, allows automatic PWM/PFM switchover for pulse skipping at light load, resulting in highest efficiency.

Table 1. Recommended Equipment

EQUIPMENT	MINIMUM REQUIREMENTS
Power supply, battery, or notebook AC adapter	5V to 24V
DC bias power supply	5V at 100mA
Dummy loads capable of sinking 4A	—
Digital multimeter (DMM)	—
Dual-trace oscilloscope	100MHz

- 3) Turn on battery power prior to +5V bias power; otherwise, the output UVLO timer will time out and the FAULT latch will be set, disabling the regulator outputs until +5V power is cycled or ON1/ON2 is toggled.
- 4) Verify that the output voltages are 1.8V and 2.5V.

Evaluating Other Output Voltages

The EV kit outputs are preset to 1.8V and 2.5V. However, the output voltages can also be adjusted between 1.0V and 5.5V by selecting R1/R2 and R3/R4 values. Select feedback resistors R1 and R3. R1 and R3 are then given by:

$$R1 \text{ (or } R3) = R2 \text{ (or } R4) \times [(V_{OUT} / V_{FB}) - 1]$$

where $V_{FB} = 1.0V$.

This EV kit includes two $10k\Omega \pm 1\%$ resistors for R2 and R4.

Jumper and Switch Settings

Table 2 lists the switch SW1 functions, and Tables 3–6 list the JU1–JU6 jumper functions.

MAX1715 Evaluation Kit

Evaluates: MAX1715

Table 3. Jumpers JU1/JU2/JU3 Functions (Switching Frequency Selection)

JU1	JU2	ON2 PIN	JU3	FREQUENCY (kHz)
Not Installed	Not Installed	Not Installed	Floating	255/345
Installed	Not Installed	Not Installed	Connected to V _{CC}	170/230
Not Installed	Installed	Not Installed	Connected to REF	340/460
Not Installed	Not Installed	Installed	Connected to GND	470/630

IMPORTANT: Don't change the operating frequency without first recalculating component values because the frequency has a significant effect on the peak current-limit level, MOSFET heating, preferred inductor value, PFM/PWM switchover point, output noise, efficiency, and other critical parameters.

Table 4. Jumper JU4 Functions (Output Voltage Selection)

SHUNT LOCATION	FB1 PIN	MAX1715 OUTPUTS
Installed	Connected to V _{CC}	V _{OUT1} = 3.3V
Not Installed	Connected to GND through R2	V _{OUT1} = 1.8V

Table 5. Jumper JU5 Functions (Fixed/Adjustable Current Limit Selection for V_{OUT1})

SHUNT LOCATION	ILIM1 PIN	CURRENT-LIMIT THRESHOLD
Installed	Connected to V _{CC}	100mV (default)
Not Installed	Connected to GND through R9. Refer to the <i>Current-Limit Circuit</i> section in the MAX1715 data sheet for information on selecting R9.	Adjustable between 50mV and 200mV

Table 6. Jumper JU6 Functions (Fixed/Adjustable Current Limit Selection for V_{OUT2})

SHUNT LOCATION	ILIM2 PIN	CURRENT-LIMIT THRESHOLD
Installed	Connected to V _{CC}	100mV (default)
Not Installed	Connected to GND through R10. Refer to the <i>Current-Limit Circuit</i> section in the MAX1715 data sheet for information on selecting R10.	Adjustable between 50mV and 200mV

MAX1715 Evaluation Kit

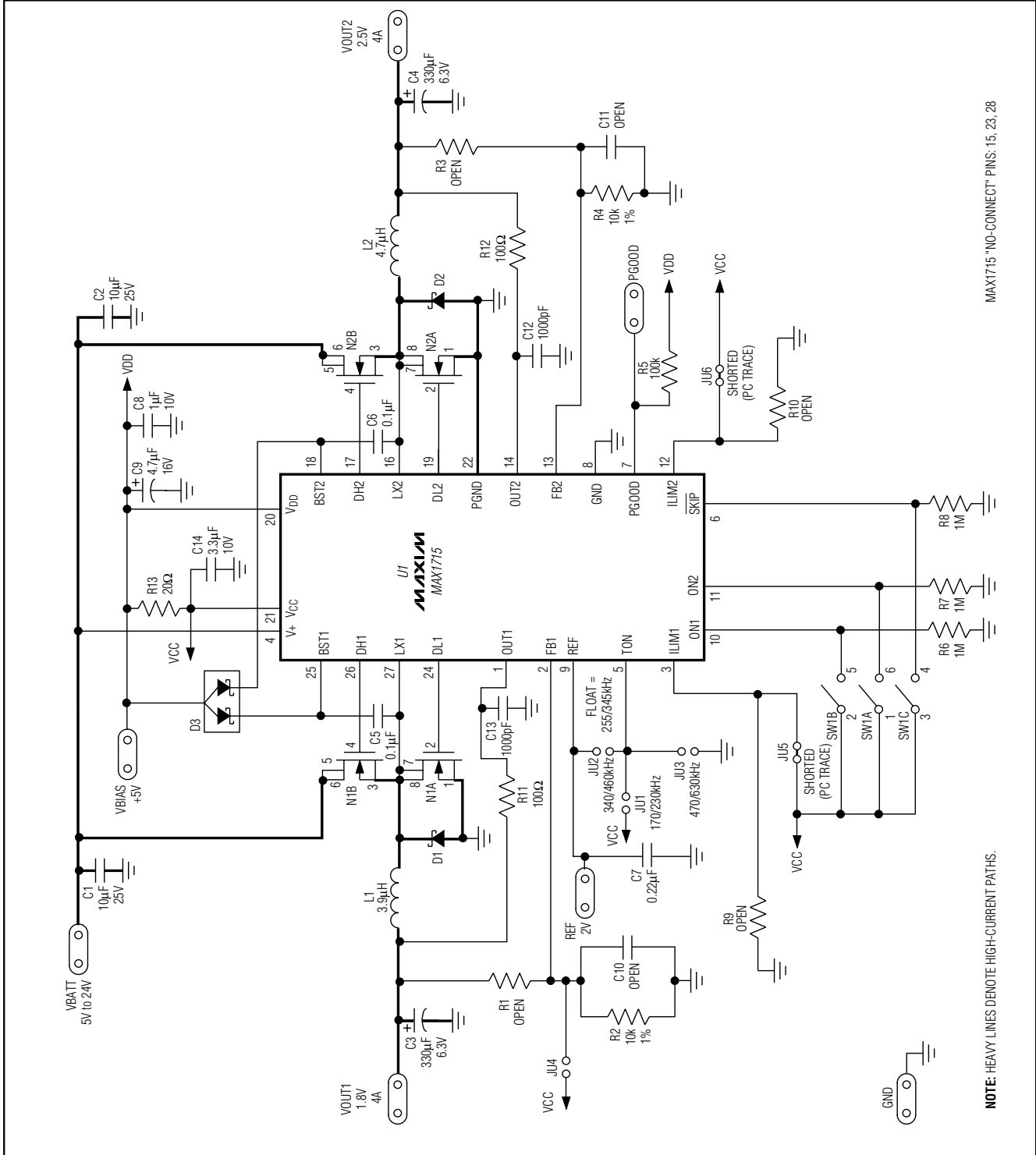

MAX1715 "NO-CONNECT" PINS: 15, 23, 28

NOTE: HEAVY LINES DENOTE HIGH-CURRENT PATHS.

Figure 1. MAX1715 EV Kit Schematic

MAX1715 Evaluation Kit

Evaluates: MAX1715

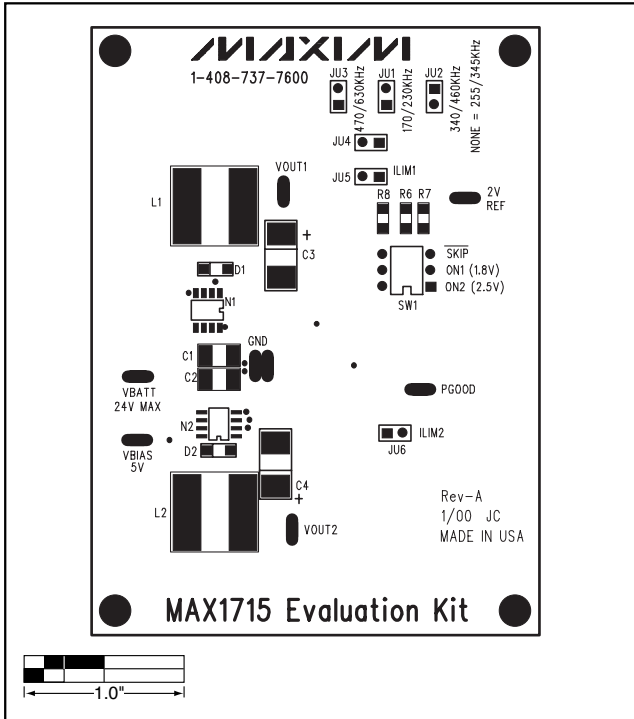

Figure 2. MAX1715 EV Kit Component Placement Guide—Component Side

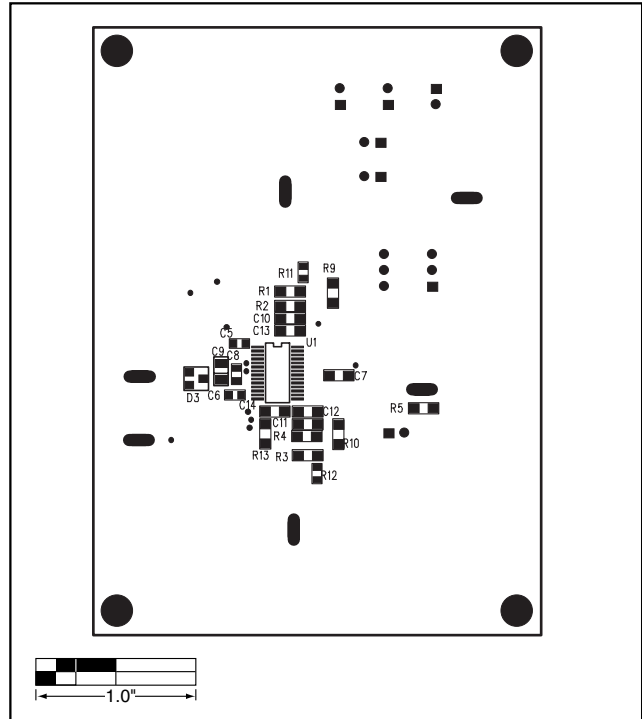

Figure 3. MAX1715 EV Kit Component Placement Guide—Solder Side

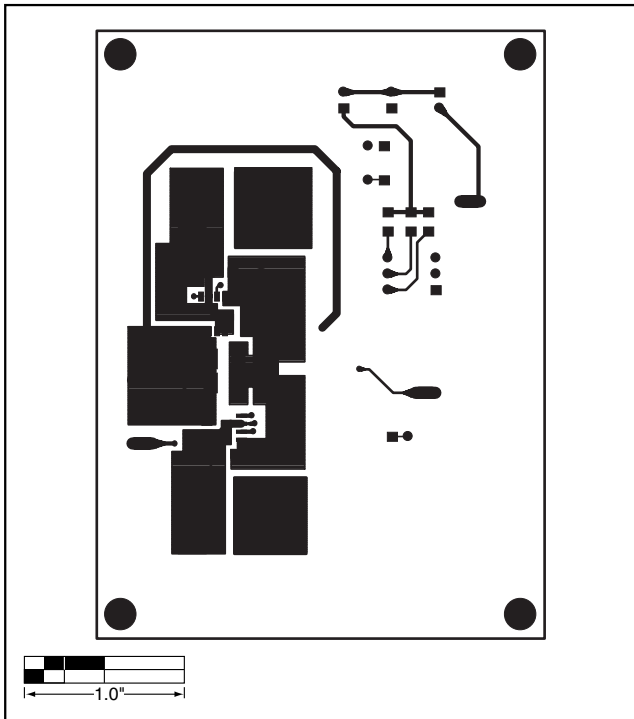

Figure 4. MAX1715 EV Kit PC Board Layout—Component Side

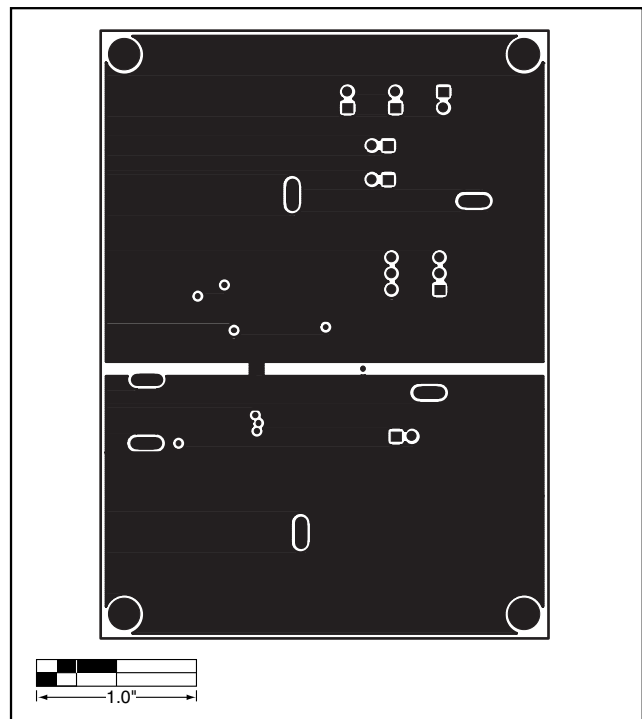

Figure 5. MAX1715 EV Kit PC Board Layout—GND Layer 2

MAX1715 Evaluation Kit

Evaluates: MAX1715

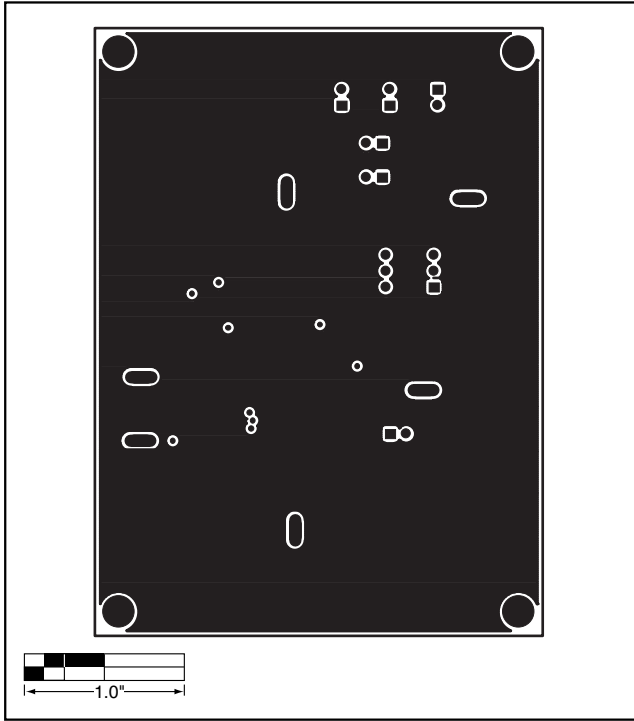

Figure 6. MAX1715 EV Kit PC Board Layout—GND Layer 3

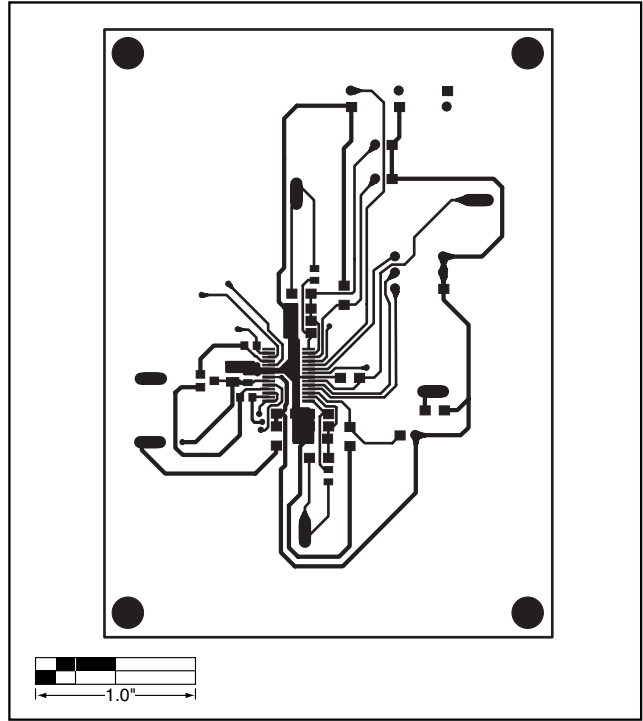

Figure 7. MAX1715 EV Kit PC Board Layout—Solder Side

Maxim cannot assume responsibility for use of any circuitry other than circuitry entirely embodied in a Maxim product. No circuit patent licenses are implied. Maxim reserves the right to change the circuitry and specifications without notice at any time.

6 _____ **Maxim Integrated Products, 120 San Gabriel Drive, Sunnyvale, CA 94086 408-737-7600**